

EXPERT SUSPENSION SOLUTIONS



Le Colloque Euro-méditerranéen de l'innovation

Tunis, le 14 octobre 2010

Elyès FAKHFAKH

CHIFFRES CLES

- **CREATION: 1981**
- **GROUPE: UFI (A.ESSASSI)**
- **EFFECTIF: 450 p (50 Cadres)**
- **CA: 50 Mio DT**



NOS PRODUITS

- **Ressorts Paraboliques**



- **Ressorts Conventionnels**



- **Air Links**



- **Barre Stabilisatrice**

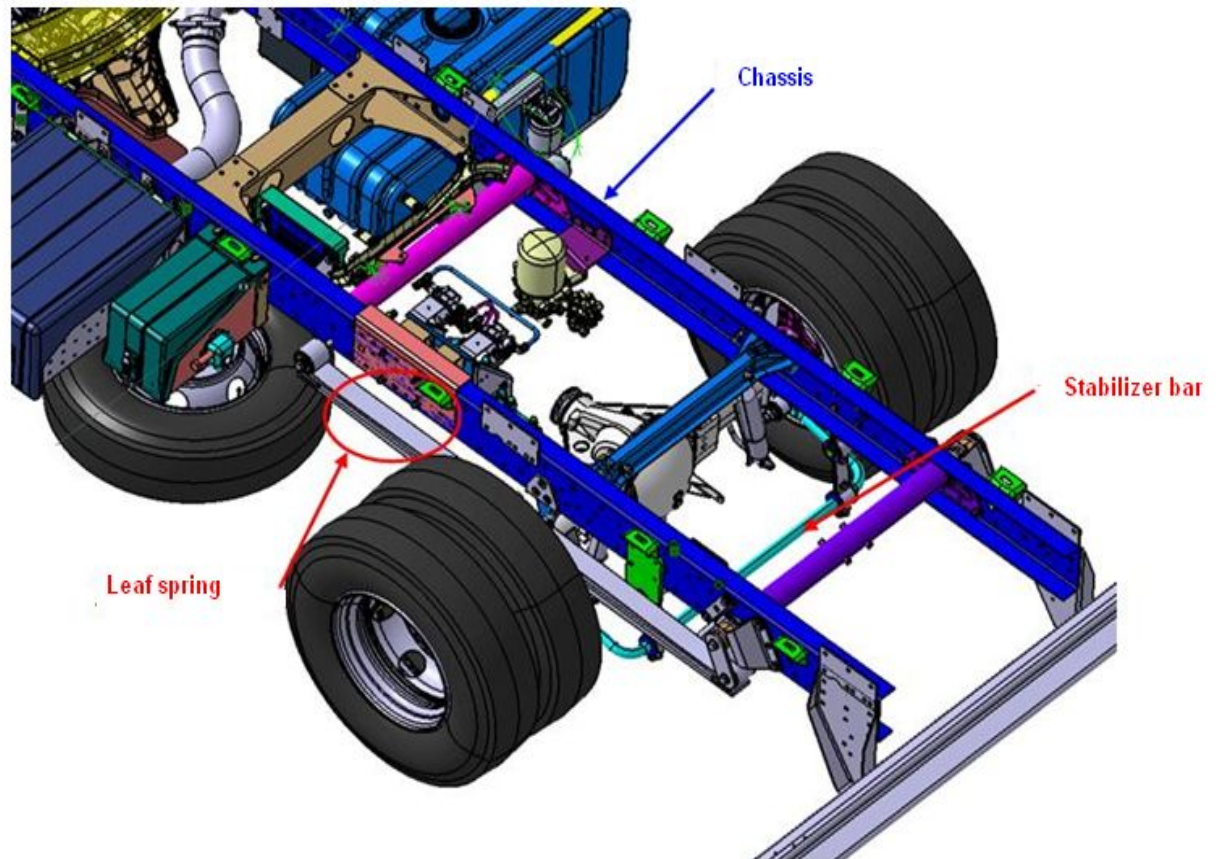

EXPERT SUSPENSION SOLUTIONS



NOS CLIENTS



IVECO



IVECO



SCANIA



MAN



EXPERT SUSPENSION SOLUTIONS



NOS CLIENTS



NOS OBJECTIFS STRATEGIQUES (CAP 2010)

- ❑ **Diversifier nos Marchés et introduire des nouveaux clients**
- ❑ **Gagner la position de partenaire-concepteur.**
- ❑ **Elargir notre gamme de produits et notre implantation internationale.**

A stylized illustration of a classical column with four fluted shafts. A white rectangular box with a black border is superimposed on the column, containing the text 'Recherche & Développement'. Below the column are two horizontal grey bars of increasing width, suggesting a base or foundation.

Recherche &
Développement

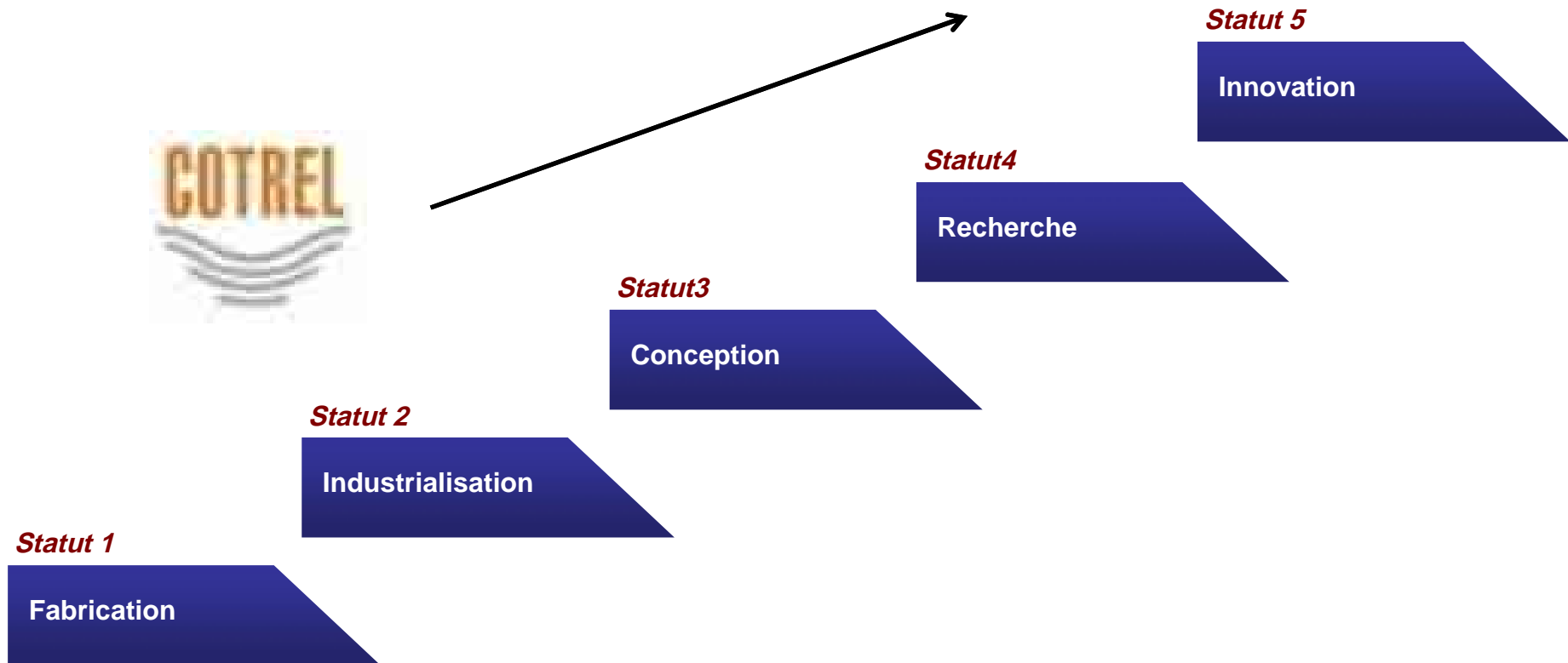

NOTRE STRATEGIE R&D

- ❑ **Structurer notre organisation R&D**
- ❑ **Renforcer nos moyens de conception, de contrôle et de testing**
- ❑ **Construire un réseau de partenaires technologiques locaux et internationaux**

❑ Structurer notre organisation de R&D

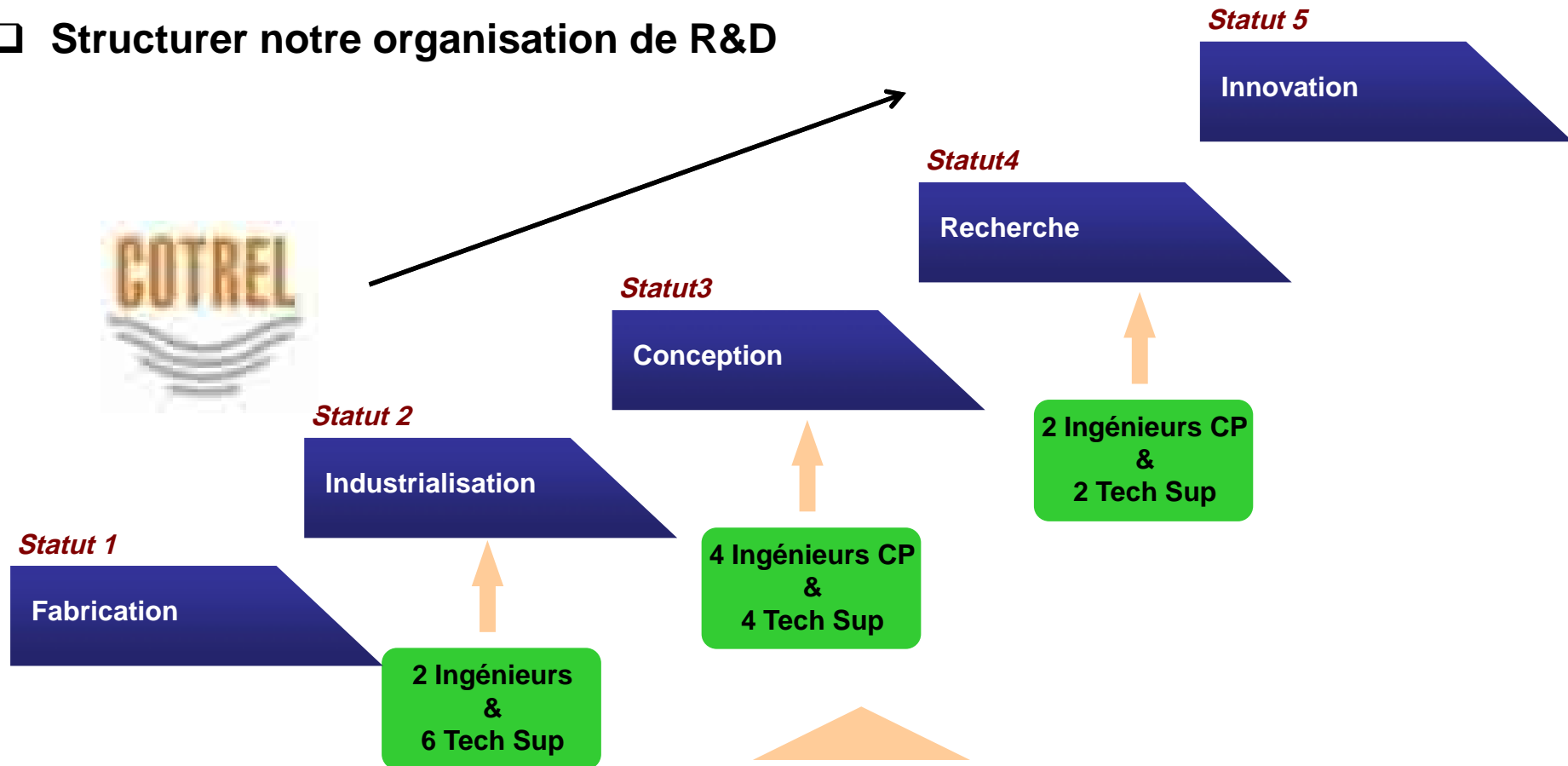

- Utilisation de la démarche ANPQP de Renault/Nissan
- Formation avancée en simulation numérique
- Formation en management et gestion de projet
- Encadrement par un réseau d'experts internationaux

❑ **Renforcer nos moyens de conception, de contrôle et de testing**

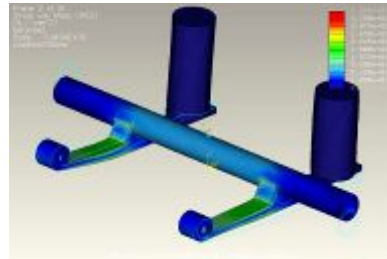
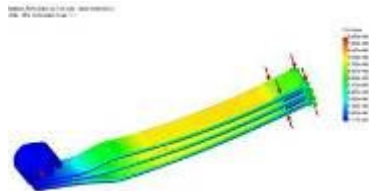

- **CATIA V5**
- **ABAQUS**
- **UNIGRAPHICS**



- **Fatigue test**
- **3D measurement**
- **Metallurgical testing**
- **Corrosion resistance test**
- **Strain gauge measurement system**

□ Construire un réseau de partenaires technologiques locaux et internationaux

Matériaux

Produits

Procédés

Simulation
Numérique

ASCOMETALCREAS



W Abrasives

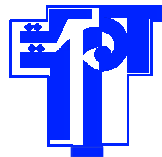

Zone Industrielle, Suresnes 92131 Paris Cedex 16



Projet d'innovation avec le PMI: optimisation du poids du ressort IVECO

- Hier



AVANT :
89 Kg



- Aujourd'hui



APRES :
77 Kg



- Demain



Investissements en R&D

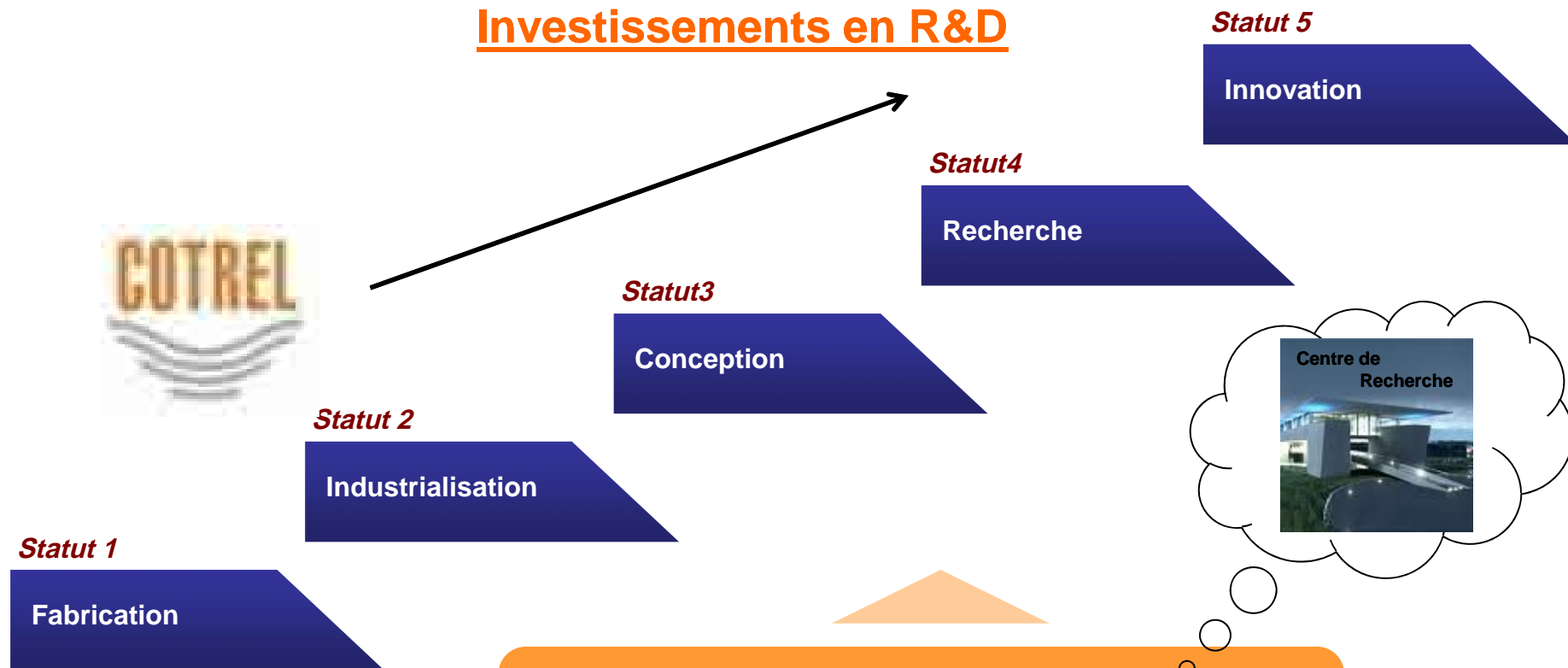

- Investissement R&D ~ 3% du CA
- 5% des 2 derniers PMN (~ 1.3 Mio DT)
- 50% Matériel/ 50% Immatériel
- Subventions ~ 50%

EXPERT SUSPENSION SOLUTIONS



Notre Avenir



Be a technological and international partner for LCV & HDT suspension solutions

